

Pos. Nr. Pos.no.	Beschreibung Description	Art.-Nr. Art.no.	Preisgruppe Price bracket
<b>72142</b>	DB BR 051	=	
<b>72143</b>		=	🔊
<b>78143</b>		~	🔊
1	Kesselboden Boiler bottom	132706	12
2	TS-Kesselleitungen Part set boiler lines	100145	9
3	Schaltstange 0,4 x 49,7 Control rod 0,4 x 49,7	100170	4
4	Schaltstange 0,4 x 93 mm Control rod 0,4 x 93 mm	100171	4
5	WITTE-Windleitblech links und rechts WITTE wind deflectors left and right	94620	12
6	TS-Fenster und Lichtleiter Part set window and light conductor	100141	9
7	TS-Kesselsteckteile Part set boiler plug-in parts	100678	13
8	TS-Sandrohr,Kesselrohr Set of sand pipes, boiler pipes	100146	9
9	GF-Schraube M2x5 mm Self-tapping screw M2x5 mm	114966	3
10	Sandrohrsatz und Griffstangen Sand pipe set and handrails	120206	9
11	Führerhaus Betr. nr. 051 745-8 Driver's cab no. 051 745-8	140757	19
12	Umlaufblech bedruckt Running board printed	127757	18
13	Kessel komplett Betr. nr. 051 745-8 Boiler assembly Loco.no. 051 745-8	140755	39
14	Schaltstange 0,4 x 100 mm Control rod 0,4 x 100 mm	100172	4
15	Nummerntafeln Number plates	140756	8
16	TS-Kessel und Tender Part set boiler and tender	120207	8
17	Stirnlichtleiter Front light conductor	131723	4
18	Loklampe klein Loco lamp small	100154	7
19	Kupplungsauflegesatz Set of coupling rod covers	100156	4
20	Kontaktträger Contact support	124996	7
21	Schaltstange 0,4 x 37 mm Control rod 0,4 x 37 mm	100169	4
22	TS - Rohre,Bremsschlauch Part set brass tube, Brake hose	125002	9
23	Griffstange Rauchkammer Handrail for smoke box	136936	4
24	Lokgewicht Loco ballast	109802	8
25	Loklampe oben Upper loco lamp	100161	3
26	Ölkanne Oil can	92453	4

Änderungen in Konstruktion und Ausführung vorbehalten  
We reserve the right to change the construction and specification

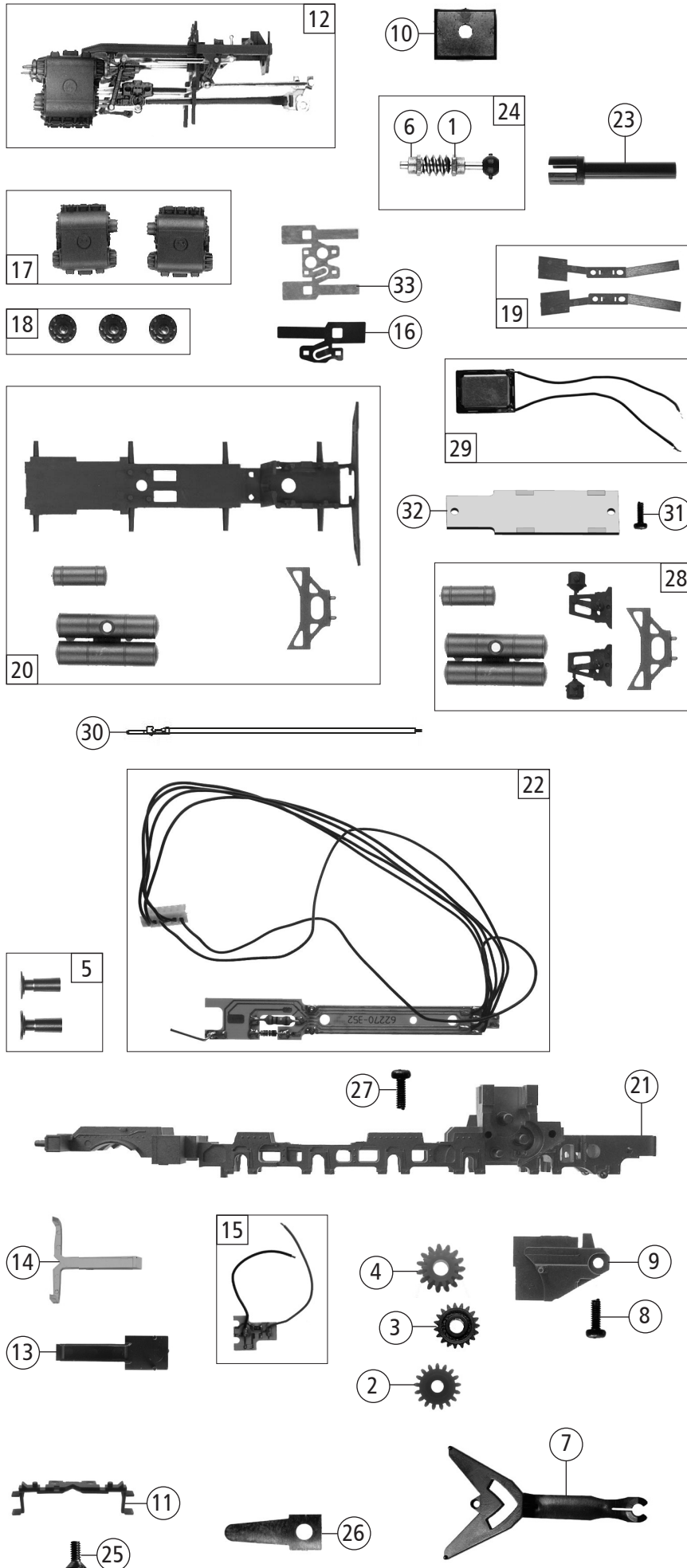

Pos. Nr. Pos.no.	Beschreibung Description	Art.-Nr. Art.no.	Preisgruppe Price bracket
72142	DB BR 051	=	
72143		=	🔊
78143		~	🔊
1	Beilagscheibe 2,1 x 4 / 0,2 mm Washer 2,1 x 4 / 0,2 mm	86108	3
2	Zahnrad Z=17 Gear wheel Z=17	86409	5
3	Zahnrad Z=19 / M=0,4 Gear wheel Z=19 / M=0,4	86417	3
4	Schneckenzahnrad Z=15/14 Worm gear wheel Z=15/14	86490	5
5	Puffer flach / gewölbt bedruckt Buffer flat / curved printed	136333	8
6	Lager für Schneckenachse Bearing for worm gear axle	89749	6
7	Lok-Tender Kupplung Coupling between loco and tender	100273	8
8	GF-Schraube M2x5 mm Self-tapping screw M2x5 mm	114966	3
9	Lokgetriebedeckel Loco gear cover	109406	12
10	Schneckenkammerdeckel Worm gearbox cover	111987	4
11	Loktreppe Loco ladder	123350	4
12	Steuerung kpl. Reversing gear complete	138562	35
13	Lichtabdeckung Light cover	122502	3
14	Stirnlichtleiter Light conductor front	131122	5
15	Stirn LED-Platine Front LED-printed circuit board	131125	13
16	Radkontakt Wheel contact	131126	5
17	Zylinderblock links und rechts Cylinder block left and right	100168	12
18	TS-Schiebereinsatz Part set slide inset	92420	3
19	Radkontakt links und rechts Wheel contact left and right	124976	6
20	TS-Umlauf Part set running board	131722	10
21	Lokgrundrahmen Loco basic frame	132123	16
22	Lokplatine kpl. Loco printed circuit board ass.	125019	20
23	Kardanhülse Cardan reception	87074	5
24	Schneckensatz mit Kardankugel Set of worm gear incl. cardan ball	100132	13
25	SK-Schraube M1,6x4 mm SK-Screw M1,6x4 mm	115161	3
26	Vorlaufgestellfeder Bogie spring	125024	3
27	GF-Schraube M1,6x4 mm Self-tapping screw M1,6x4 mm	114850	3
28	Teilesatz 5 Part set 5	107371	9
<b>Sound</b>			
29	Lautsprecher Loudspeaker	129524	16
30	Kontaktstift mit Litze Contact pin with lead	132794	4
31	GF-Schraube M1,6x4 mm Self-tapping screw M1,6x4 mm	114850	3
32	Lautsprecherplatine Loudspeaker printed circuit board	133613	11
<b>AC - Wechselstrom</b>			
33	Radkontakt Wheel contact	131912	4

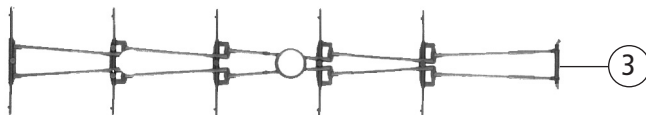
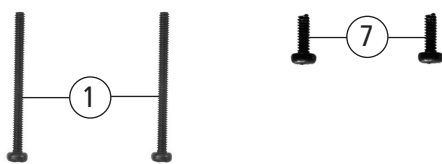
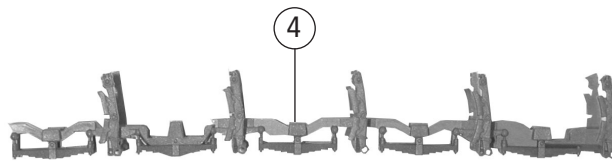
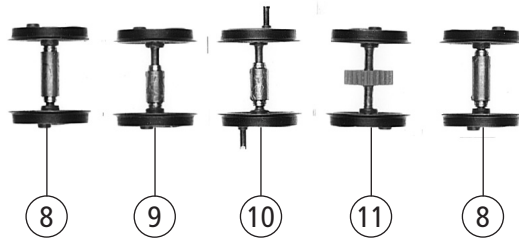
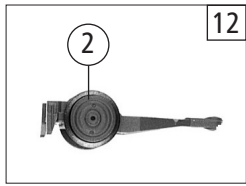

Pos. Nr. Pos.no.	Beschreibung Description	Art.-Nr. Art.no.	Preisgruppe Price bracket
72142	DB BR 051	=	
72143		=	🔊
78143		~	🔊
1	GF-Schraube M2x25 mm Self-tapping screw M2x25 mm	115533	3
2	Vorlaufgradsatz Pony truck wheelset	90689	9
3	Bremsgestänge Brake rigging	100153	3
4	Bremsrahmen Brakes frame	100274	12
5	TS - Treibstangen bedruckt Part set of driving rod printed	134762	18
6	TS-Stoppel Part set plugs	138069	5
7	GF-Schraube M2x4 mm Self-tapping screw M2x4 mm	114877	3
8	Radsatz 1/5 m.Achslager lang lackiert Wheelset 1/5 w.axle bearing long painted	131593	12
9	Kuppelradsatz 2 m.Achslager klein lackiert Coupled wheelset 2 w.axle bearing small	131594	12
10	Treibradsatz 3 m.Achslager klein lackiert Driving wheel 3 w.axle bearing small painted	131595	12
11	Kuppelradsatz 4 m.Zahnrad lackiert Coupled wheelset 4 w.gear wheel painted	131596	12
12	Vorlaufgestell komplett Frontside carrying wheelset complete	100949	17

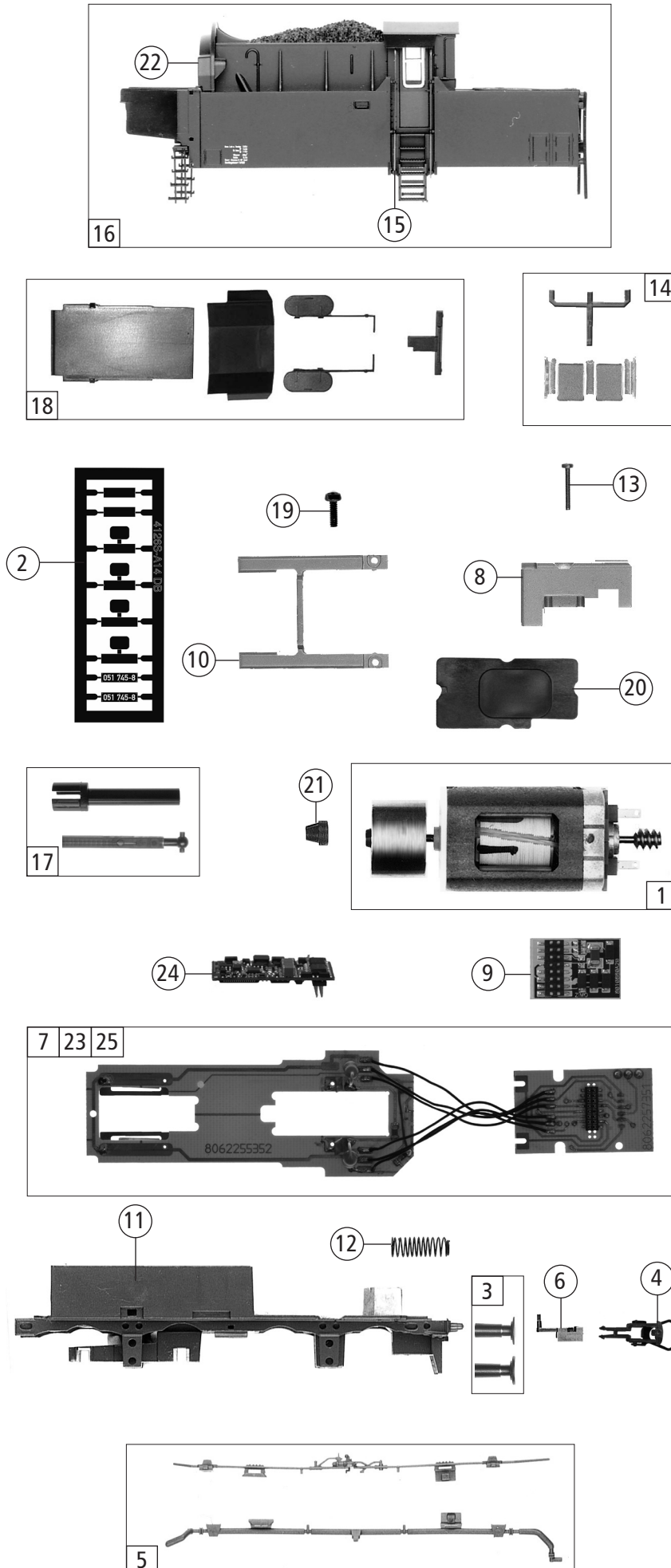

Pos. Nr. Pos.no.	Beschreibung Description	Art.-Nr. Art.no.	Preisgruppe Price bracket
72142	DB BR 051	=	
72143		=	🔊
78143		~	🔊
1	Motor Motor	85131	28
2	Nummerntafeln Number plates	140756	8
3	Puffer flach / gewölbt bedruckt Buffer flat / curved printed	136333	8
4	Standardkupplung Standard coupling	89246	6
5	Tenderleitungssatz Tender line set	101414	7
6	Kupplungskammer Coupling reception	108225	4
7	Tenderplatine kpl. mit LED Tender printed circuit board complete w.LED	131130	24
8	Tendergewicht Tender ballast	101413	8
9	Brückenstecker klein Connector small	129630	10
10	Motorbefestigung Motor fixation	101417	8
11	Tendergrundrahmen Tender basic frame	132125	16
12	Bürstenfeder Brush spring	114197	3
13	GF-Schraube M1,6x10 mm Self-tapping screw M1,6x10 mm	114881	3
14	TS - Tenderfenster geprägt, Lichtleiter Part set tender window,light conductor	136924	8
15	Griffstange Tender Handrail for tender	108234	3
16	Tendergehäuse kpl. 051 745-8 Tender body ass. 051 745-8	140754	20
17	Kardanwelle und Kardanhülse Cardan shaft and cardan reception	111765	4
18	TS-Tender Part set tender	108815	10
19	GF-Schraube M1,6x6 mm Self-tapping screw M1,6x6 mm	114836	3
20	Isolierplatte Insulating plate	131630	4
21	Kardanschale kurz 1,5mm Cardan reception short 1,5mm	87129	4
22	Tenderkabine Tender cabin	108814	12
<b>Sound</b>			
23	Tenderplatine kpl. mit LED Tender printed circuit board complete w.LED	132128	28
24	Sounddecoder Sound-decoder	129300	39
<b>AC-Wechselstrom</b>			
25	Tenderplatine kpl. mit LED Tender printed circuit board complete w.LED	136938	28

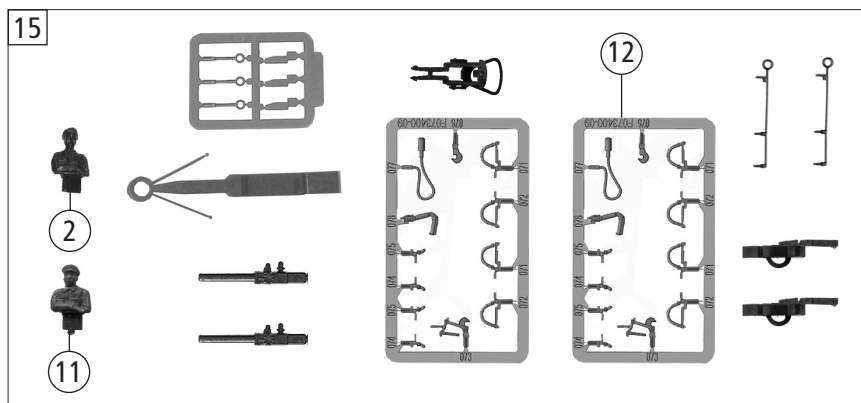
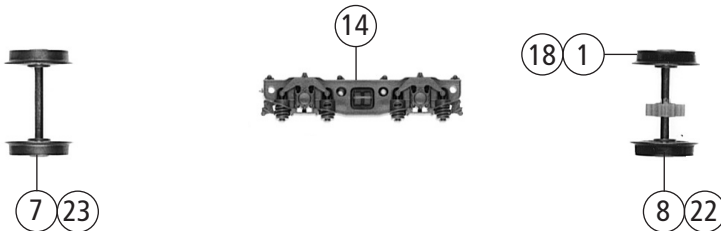
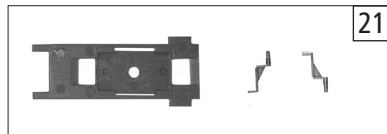
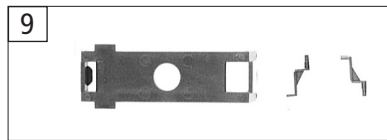
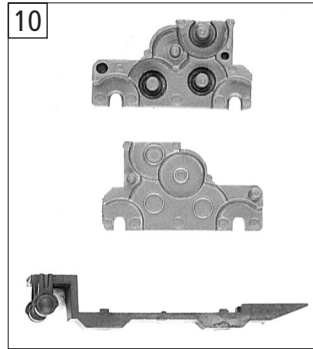
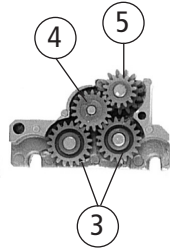
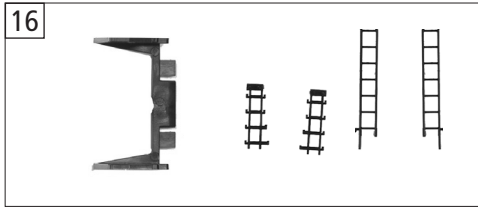

Pos. Nr. Pos.no.	Beschreibung Description	Art.-Nr. Art.no.	Preisgruppe Price bracket
72142	DB BR 051	=	
72143		=	🔊
78143		~	🔊
1	Hafrings.10Stk. 10,3-12,8mm Traction tyres set 10 pcs. 10,3-12,8mm	40069	---
2	Lokführer Loco driver	89724	6
3	Zahnrad Z=19/M=0,4 Gear wheel Z=19/M=0,4	86417	3
4	Zahnrad Z=17 M=0,4 mm G Gear wheel Z=17 M=0,4 mm G	86418	5
5	Schneckenzahnrad Z=15/14 Worm gear wheel Z=15/14	86490	5
6	GF-Schraube M2x4 mm Self-tapping screw M2x4 mm	114877	3
7	Radsatz ohne Zahnrad ohne Haftring Wheelset w/o gear wheel w/o trac.tyre	121877	9
8	Radsatz mit 2 Haftringen mit Zahnrad Wheelset w.2 traction tyres w.gear wheel	90690	11
9	Teilesatz 4 Tender Part set 4 tender	100167	8
10	Tendergetriebebesatz 3-teilig Tender gear set 3-parts	100136	13
11	Heizer Fireman	89725	6
12	TS-Bremsschläuche und Zughaken Part set of brake tubes & coupling hooks	139832	7
13	Druckfeder Pressure spring	108226	3
14	Blende für Tender Bogie for Tender	108227	9
15	Zurüstbeutel Bag with accessories	140758	15
16	TS-Tendertür und Leitern Part set tender door and ladders	108233	12
17	Ansatzschraube M2x5 mm Flanged screw M2x5 mm	85669	4
<b>AC-Wechselstrom</b>			
18	Hafringsatz 10Stk.10,3-12,4mm Traction tyres set 10pcs. 10,3-12,4mm	40074	---
19	Schleifer 46 mm Center pick-up 46 mm	86031	14
20	GF-Schraube M1,6x5 mm Self-tapping screw M1,6x5 mm	115269	3
21	TS-Achsdeckel, Tendertritte Part set axle cover, tender treads	109929	8
22	Radsatz mit 2 Haftringen mit Zahnrad Wheelset w.2 traction tyres w.gear wheel	109889	12
23	Radsatz ohne Zahnrad ohne Haftring Wheelset w/o gear wheel w/o trac.tyre	108304	10

Ersatzteile erhalten Sie direkt unter [www.roco.cc](http://www.roco.cc), bei Ihrem Fachhändler oder Ihrer Landesvertretung:  
Spare parts can be ordered directly at [www.roco.cc](http://www.roco.cc) and from your local dealer or country representative.